

ITEM NO:(250702-QH-ZR) (250702-QF-ZR) (250702-QB-ZR) (250702-QH-PU)(250702-QF-PU) (250702-QB-PU)
(250702-KH-ZR) (250702-KF-ZR) (250702-KB-ZR) (250702-KH-PU)(250702-KF-PU) (250702-KB-PU)

SKU:(NICOTQHB) (NICOTQFR)(NICOTQBS) (NICOLQHB) (NICOLQFR) (NICOLQBS)

SKU:(NICOTKHB) (NICOTKFR)(NICOTKBS) (NICOLKHB) (NICOLKFR) (NICOLKBS)

N ° D'ARTICLE: (250702-QH-ZR)(250702-QF-ZR) (250702-QB-ZR) (250702-QH-PU)(250702-QF-PU) (250702-QB-PU)
(250702-KH-ZR) (250702-KF-ZR) (250702-KB-ZR) (250702-KH-PU)(250702-KF-PU) (250702-KB-PU)

SKU:(NICOTQHB) (NICOTQFR)(NICOTQBS) (NICOLQHB) (NICOLQFR) (NICOLQBS)

SKU:(NICOTKHB) (NICOTKFR)(NICOTKBS) (NICOLKHB) (NICOLKFR) (NICOLKBS)

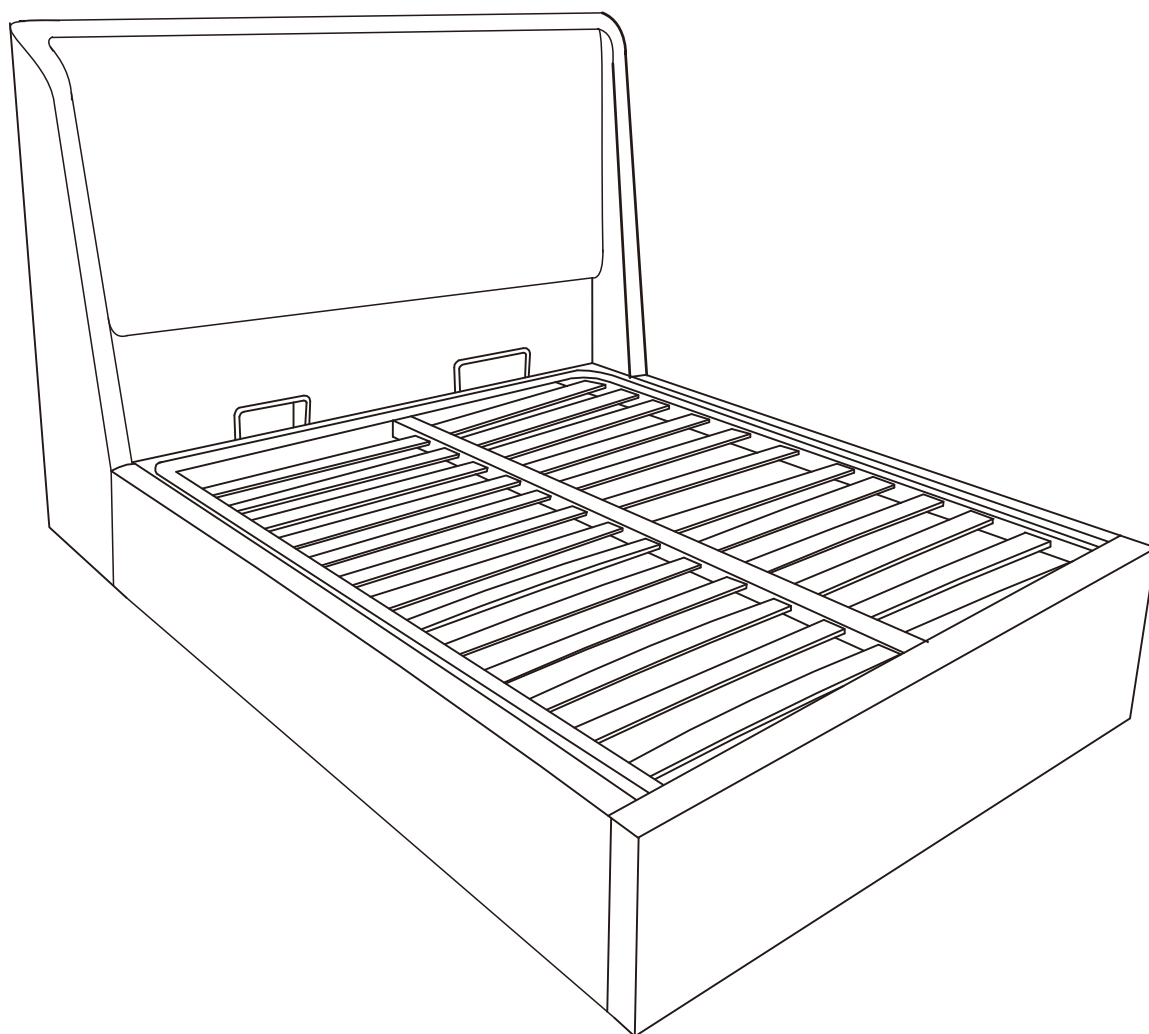







Note: Do not full tighten all bolts until the bed complete assembly.

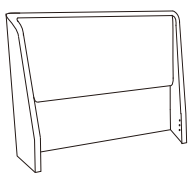
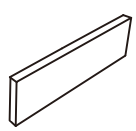
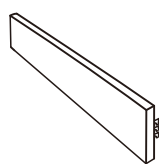
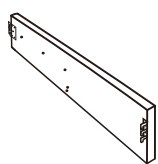
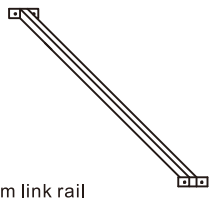
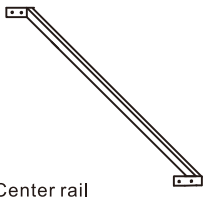





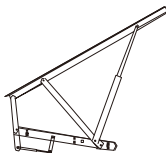
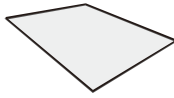



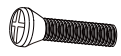

Tel qu'illustré. Attendre avant de serrer complètement les boulons.

Made in China
FABRIQUE EN CHINE

PARTS LIST/Liste des pièces

<p>A</p>  <p>Headboard /Tête de lit</p> <p>1pc</p>	<p>B</p>  <p>Footboard /Pied de pied</p> <p>1pc</p>	<p>C</p>  <p>Bed side panel /Panneau côté lit</p> <p>1pc</p>	<p>D</p>  <p>Bed side panel /Panneau côté lit</p> <p>1pc</p>
<p>E</p>  <p>Mechanism link rail /Mécanisme rail de liaison</p> <p>2pcs</p>	<p>F</p>  <p>Bedrail Center rail /Bedrail Centre Rail</p> <p>1pc</p>	<p>G</p>  <p>Mattress slats /Lamettes de matelas</p>	<p>H</p>  <p>Support leg /floating /Jambe de soutien / flottant</p> <p>2pcs</p>
<p>I</p>  <p>Mattress U bracket /Bracket matelas U</p> <p>2PCS</p>	<p>J</p>  <p>Mattress stopper /Bouchon de matelas</p> <p>2pcs</p>	<p>K</p>  <p>Handle /Poignée</p> <p>1PC</p>	<p>L</p>  <p>Bed frame bracket /Support de cadre de lit</p> <p>3pcs</p>
<p>M</p>  <p>Lift mechanism /Mécanisme de levage</p> <p>2pcs</p>	<p>N</p>  <p>Dust cover /Couverture poussière</p> <p>1pc</p>		

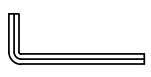
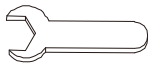
HARDWARE PACKED LIST IN BOX

<p>1</p>  <p>Bolt/Boulon ØM6*30MM</p> <p>4pcs</p>	<p>2</p>  <p>Bolt/Boulon ØM8*30MM</p> <p>24pcs</p>	<p>3</p>  <p>Bolt/Boulon ØM8*45MM</p> <p>12pcs</p>	<p>4</p>  <p>Bolt/Boulon ØM8*70MM</p> <p>2pcs</p>
<p>5</p>  <p>Bolt/Boulon ØM8*20MM</p> <p>8pcs</p>	<p>6</p>  <p>Bolt/Boulon ØM8*45MM</p> <p>6pcs</p>	<p>7</p>  <p>Anti-slip nut /écrou antidérapant ØM8</p> <p>14pcs</p>	<p>8</p>  <p>Nut/Noix ØM8</p> <p>14pcs</p>
<p>9</p>  <p>Flat Washer /rondelle plate ØM8</p> <p>52pcs</p>	<p>10</p>  <p>Flat Washer /rondelle plate ØM6</p> <p>4pcs</p>	<p>11</p>  <p>Allen Key /Clé Allen ØM8</p> <p>1pc</p>	<p>12</p>  <p>Allen Key /Clé Allen ØM6</p> <p>1pc</p>
<p>13</p>  <p>Wrench/clé ØM8</p> <p>1pc</p>	<p>14</p>  <p>spring washer /rondeuse ressort ØM8</p> <p>24pcs</p>	<p>15</p>  <p>spring washer /rondeuse ressort ØM6</p> <p>4pcs</p>	

step1

Schritt1

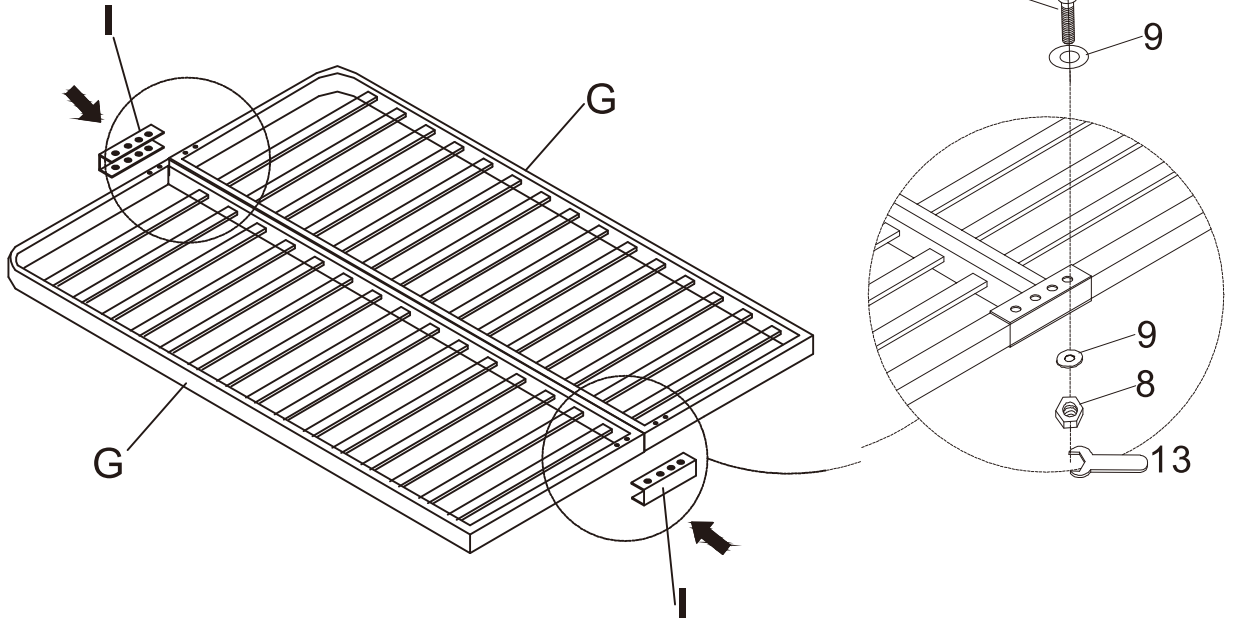

3	9	8	11	13
∅ M8*45mm 8pcs	∅ M8 16pcs	∅ M8 8pcs	∅ M8 1pc	∅ M8 1pc

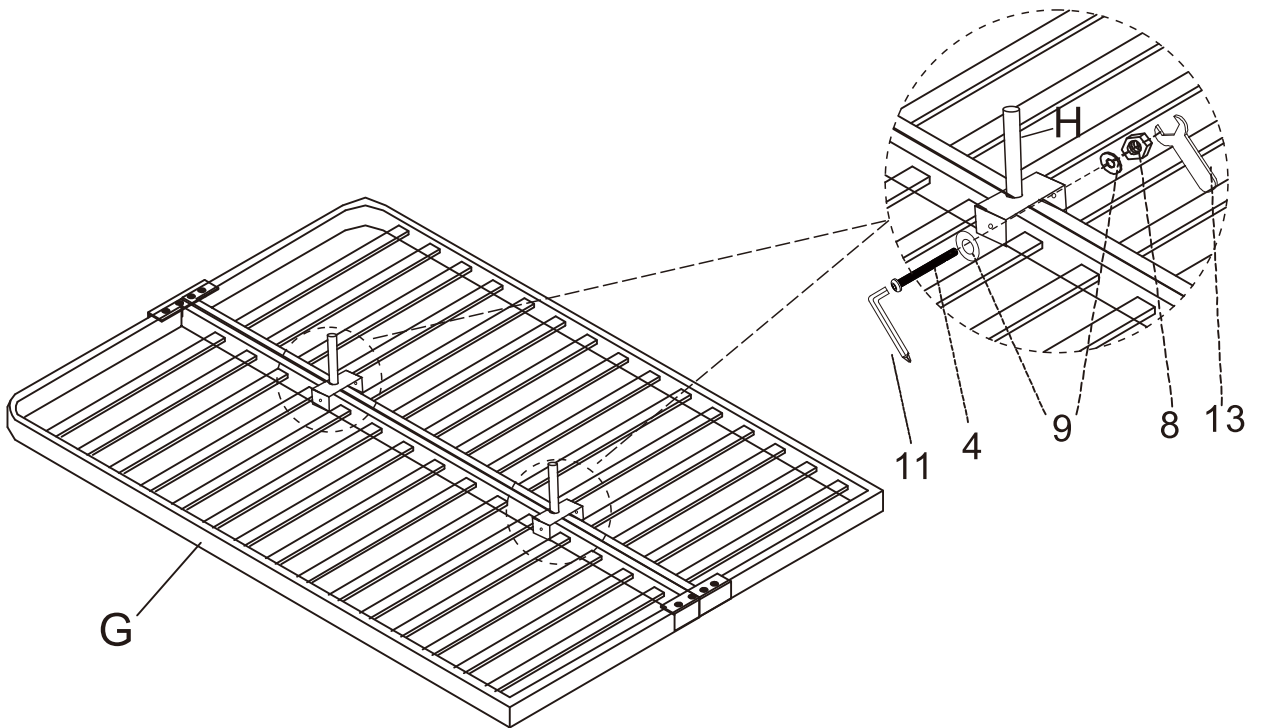

9	8	11	13	4
∅ M8 4pcs	∅ M8 2pcs	∅ M8 1pc	∅ M8 1pc	∅ M8*70mm 2pcs

step 3

Schritt 3

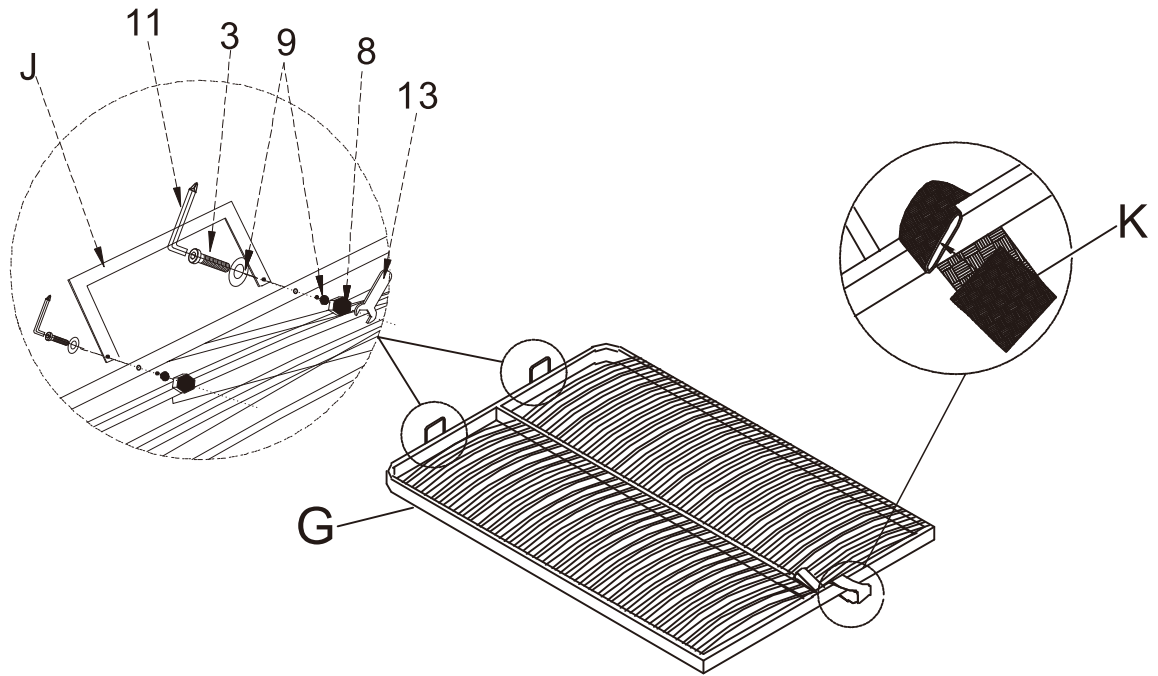

3	9	8	11	13
∅ M8*45mm 4pcs	∅ M8 8pcs	∅ M8 4pcs	∅ M8 1pc	∅ M8 1pc

step 4

Schritt 4

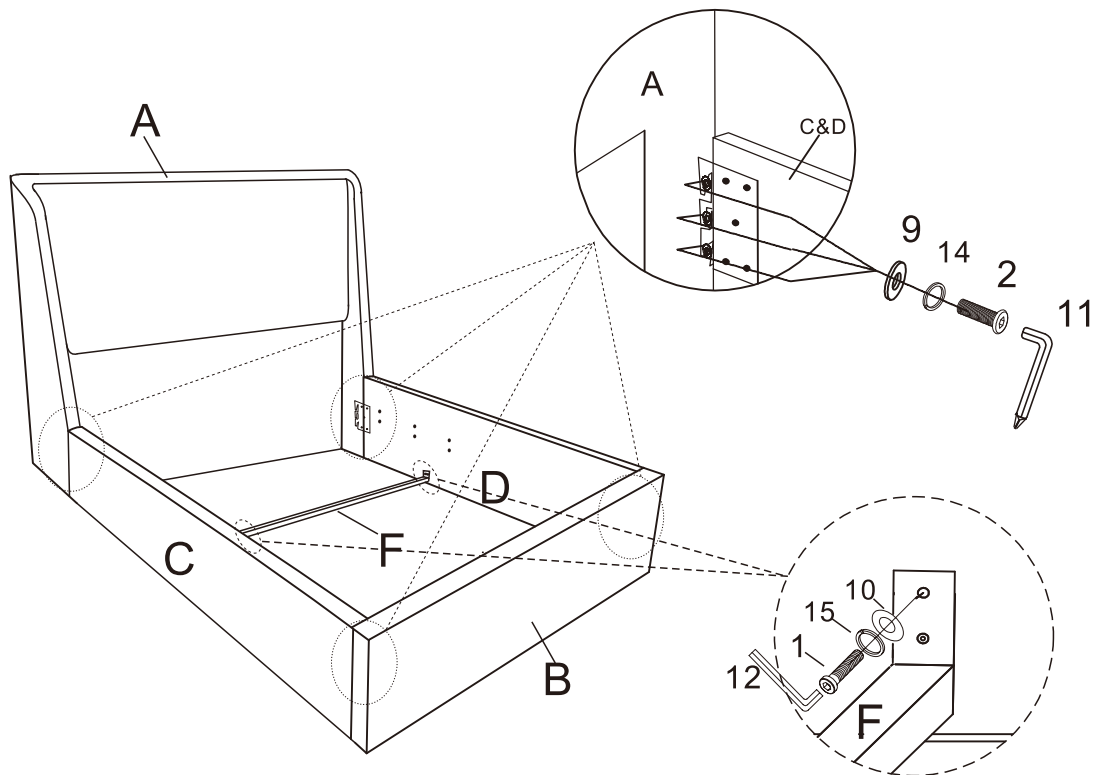

2	9	11	10	12	1	14	15
∅ M8*30mm 12pcs	∅ M8 12pcs	∅ M8 1pc	∅ M6 4pcs	∅ M6 1pc	∅ M6*30mm 4pcs	∅ M8 12pcs	∅ M6 4pcs

step 5

Schritt 5

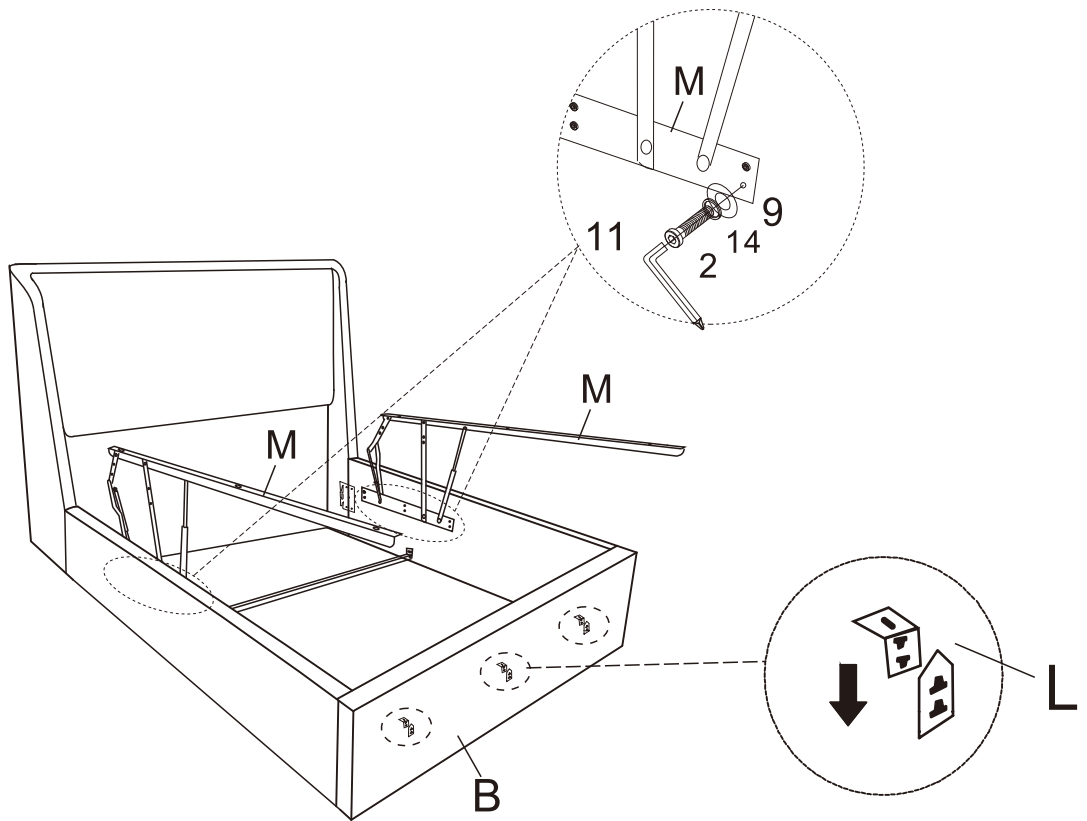

2	9	11	14
∅ M8*30mm 12pcs	∅ M8 12pcs	∅ M8 1pc	∅ M8 12pcs

step 6



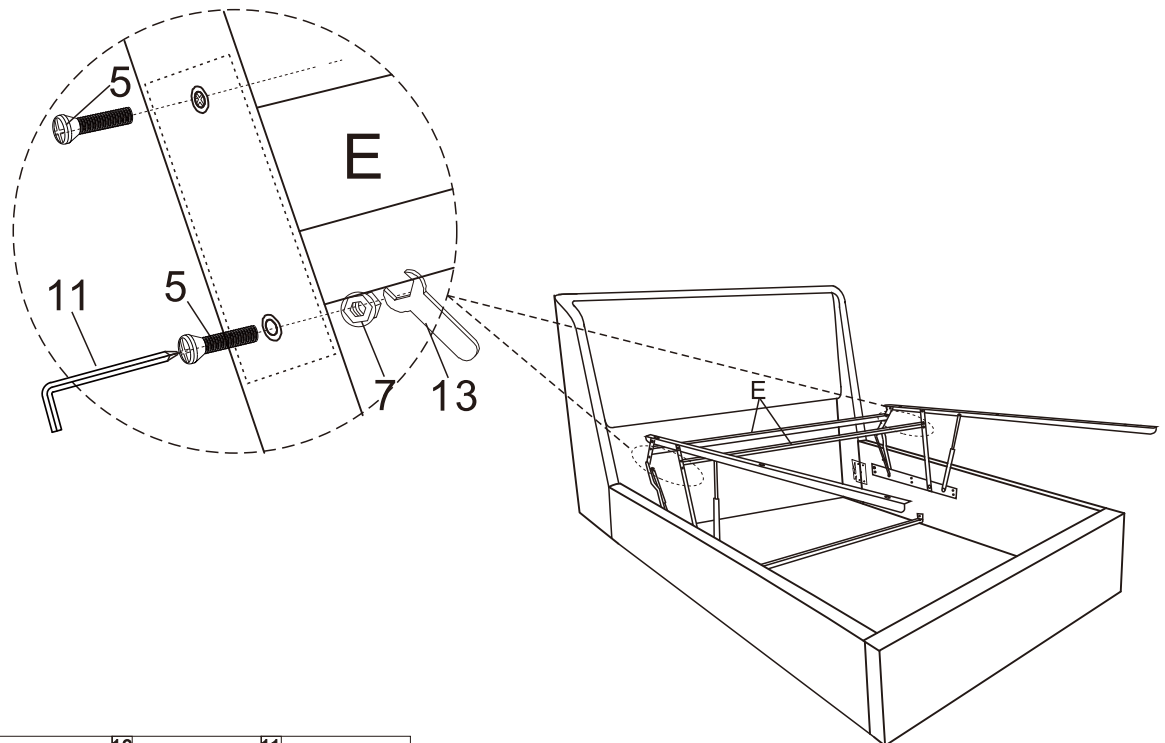

Schritt 6

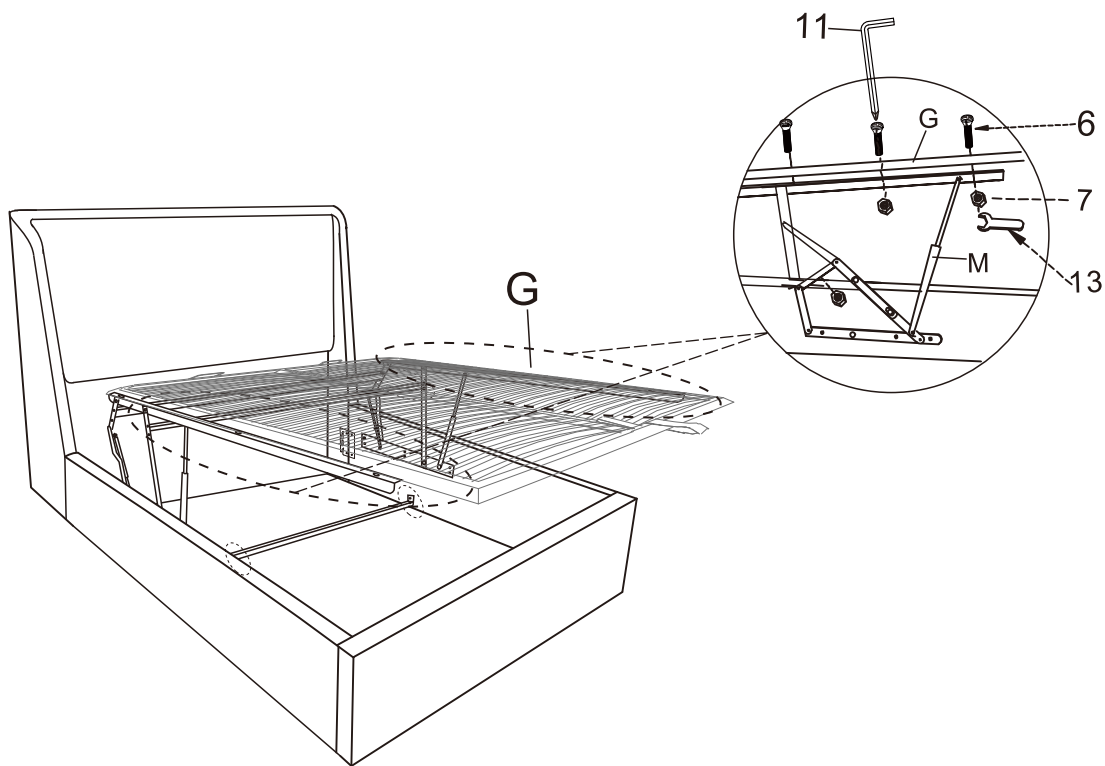

5	7	13	11
∅ M8*20mm 8pcs	∅ M8 8pcs	∅ M8 1pc	∅ M8 1pc

step 7
Schritt 7



6	7	13	11
			
∅ M8*45mm 6pcs	∅ M8 6pcs	∅ M8 1pc	∅ M8 1pc

step 8
Schritt 8

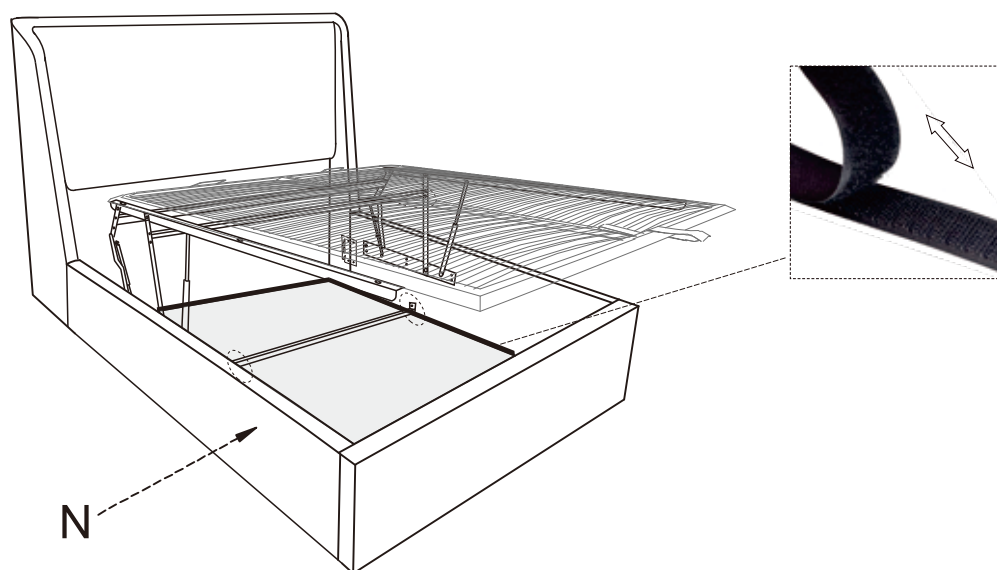

step 9
Schritt 9

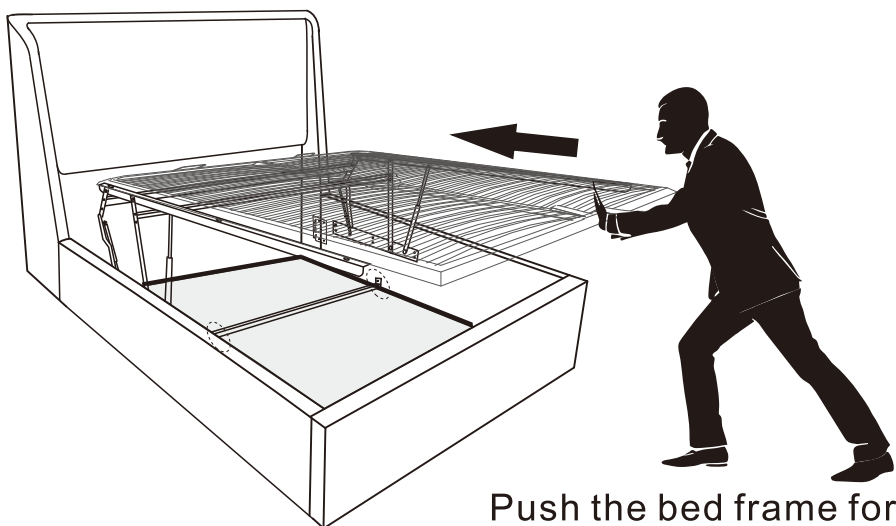

Push the bed frame forward to the headboard with a pressure at a 45° angle down.

/Poussez le cadre du lit vers l'avant vers la tête de lit en exerçant une pression à un angle de 45° vers le bas.

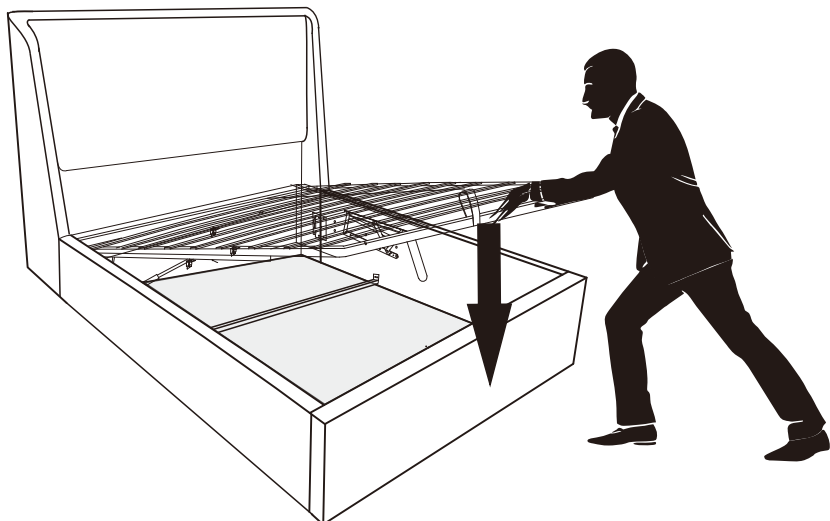

Press the mattress support frame down to the bed
/Appuyez sur le cadre de soutien du matelas vers le bas pour le fixer au lit.

