

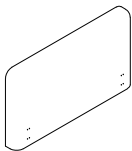

ASSEMBLY INSTRUCTIONS / NOTICE D' ASSEMBLAGE
DESCRIPTION : LUKA FULL BED/ LIT DOUBLE LUKA
ITEM: LUKATFHB/ LUKATFFB/ LUKATFRL
LUKAGFHB/ LUKAGFFB/ LUKAGFRL

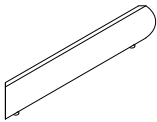
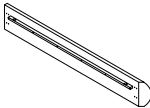
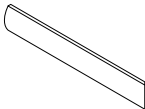

IMPORTANT NOTES / NOTE IMPORTANTE:

- .Place all wooden parts on a clean and smooth surface such as a rug or carpet to avoid scratching the parts.
/ placer les pièces sur une surface propre et lisse tel qu'une couverture ou un tapis pour éviter d'endommager les pièces.
- .Kindly follow the assembly instructions step by step . / Veuillez suivre la notice d'assemblage, pas à pas.
- .Do not tighten all screws and bolts until the product is fully assembled./Ne serrer les vis et boulons à fond que lorsque le produit est entièrement assemblé.
- .Keep all hardware parts out of reach of children./Gardez les pièces de quincaillerie hors de la portée des enfants

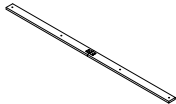
PARTS IDENTIFICATION / IDENTIFICATION DES PIÈCES

A		B		C	
	Head Board (1 pc) La tête de lit (1 pce)		Foot Board (1 pc) Pied de lit (1 pce)		Right side of bed (1 pc) Côté droit du lit (1 pce)
D		E		F	
	Left side of bed (1 pc) Côté gauche du lit (1 pce)		Bed Slat (16pcs/1set) Lattes du lit (16 pces/1jeu)		Bed Slat Support (4 pcs) Lattes de lit - Support (4 pces)
G					
	Middle Slat (1 pc) Lattes du milieu (1 pce)				

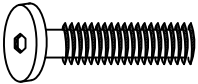
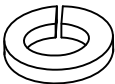
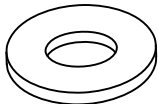
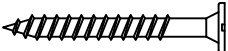
HARDWARE LIST / LISTE DES OUTILS

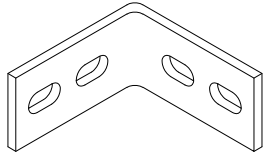
1		2		3	
	(5/16" x 1-1/4") Bolt 1 (32 pcs) Boulon 1 (32 pces)		(5/16" x 13) Spring Washer (32 pcs) Rondelle frein (32 pces)		(5/16" x 19) Flat Washer (32 pcs) Rondelle plate (32 pces)
4		5		6	
	Screw (32 pcs) Vis (32 pces)		Allen Key (1 pc) Clé hexagonale (1 pce)		L-shape metal plate (8 pc) Plaque métallique en forme de L (8 pce)

ASSEMBLY INSTRUCTIONS / NOTICE D' ASSEMBLAGE
DESCRIPTION : LUKA FULL BED/ LIT DOUBLE LUKA
ITEM: LUKATFHB/ LUKATFFB/ LUKATFRL
LUKAGFHB/ LUKAGFFB/ LUKAGFRL

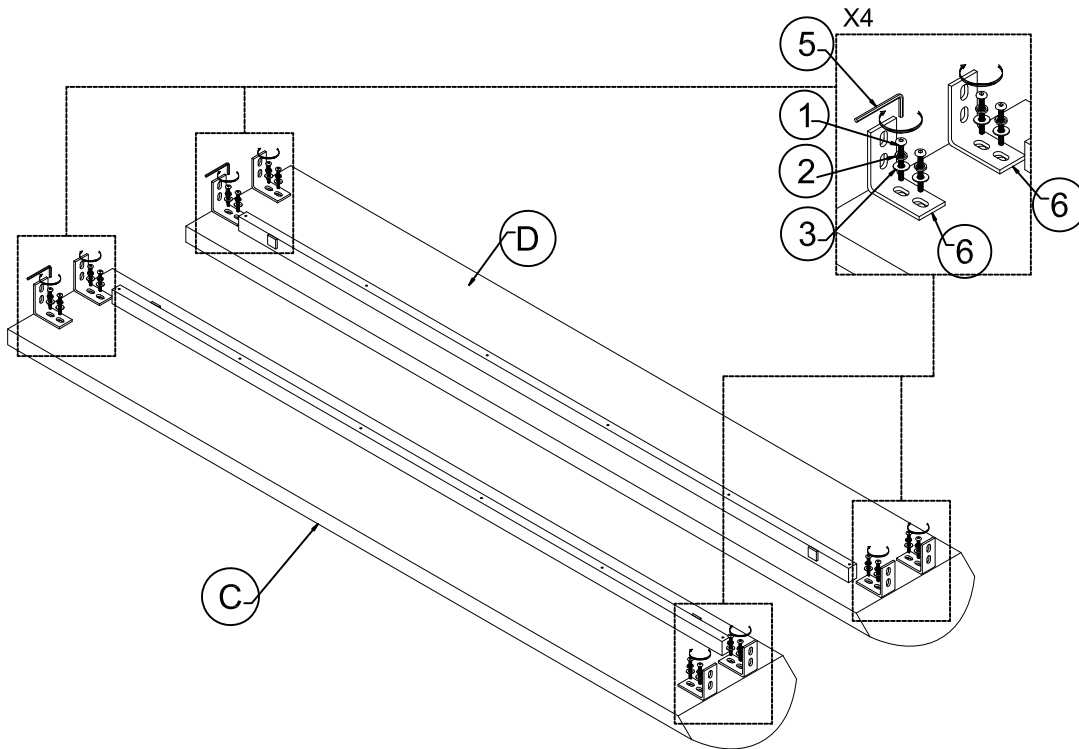

STEP 1 / ÉTAPE 1

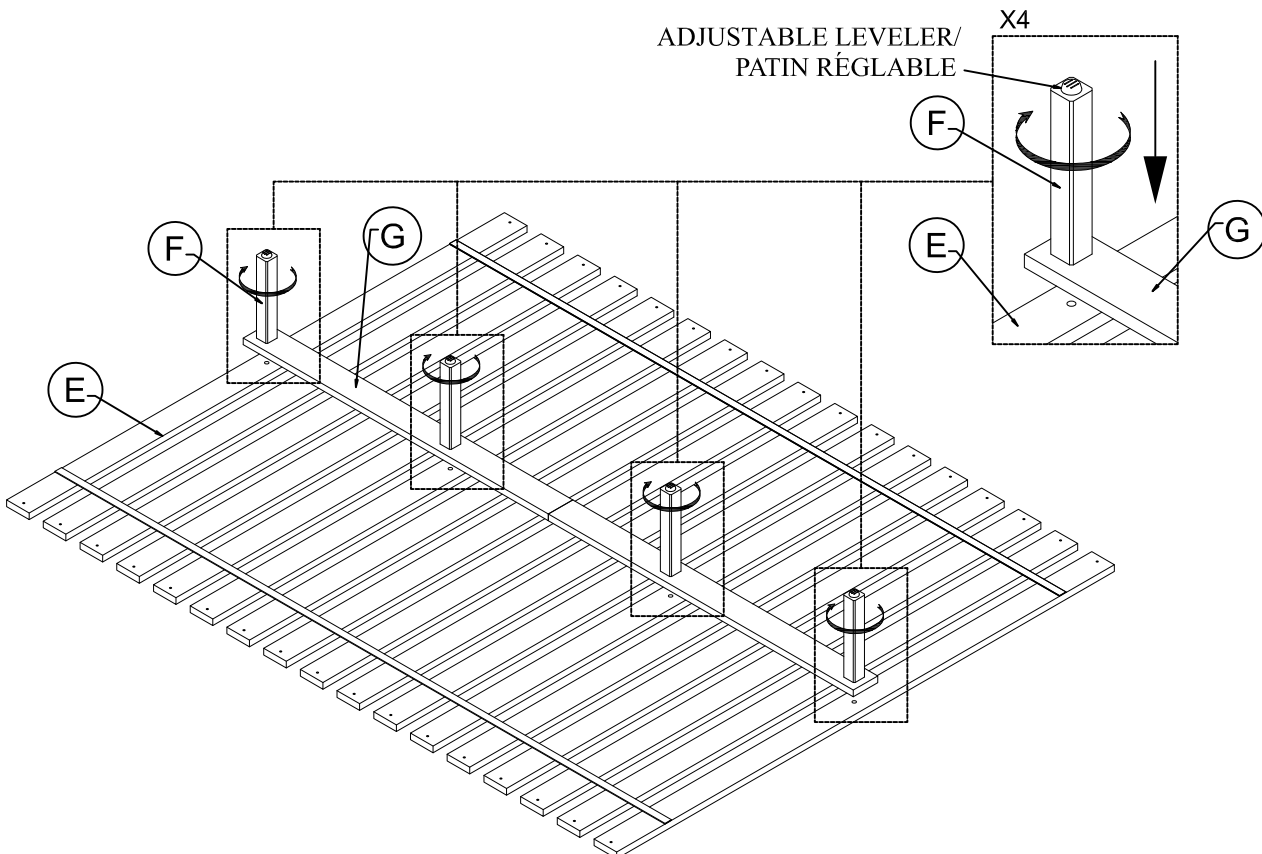

STEP 2 / ÉTAPE 2

ASSEMBLY INSTRUCTIONS / NOTICE D' ASSEMBLAGE
DESCRIPTION : LUKA FULL BED/ LIT DOUBLE LUKA
ITEM: LUKATFHB/ LUKATFFB/ LUKATFRL
LUKAGFHB/ LUKAGFFB/ LUKAGFRL

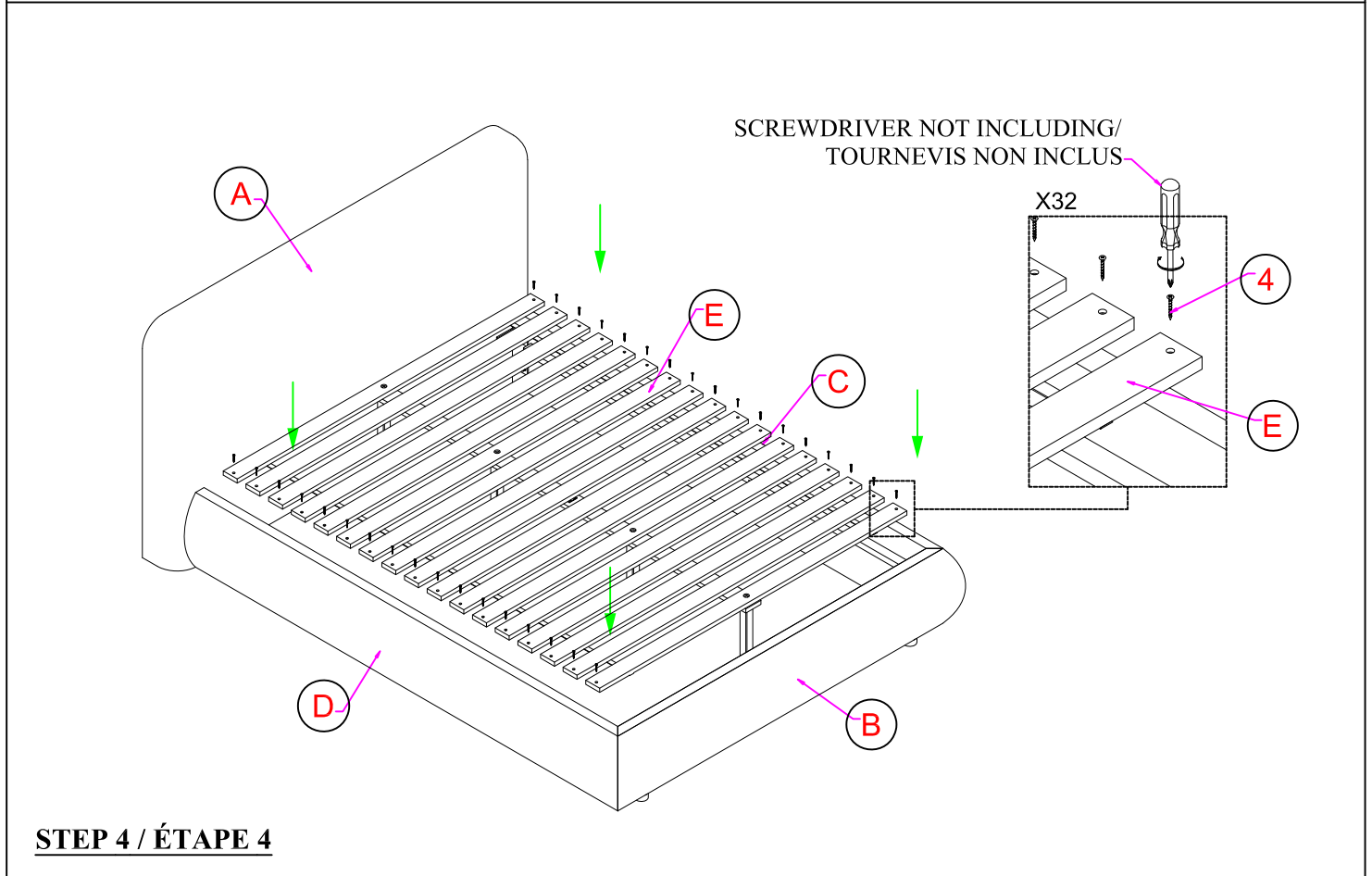
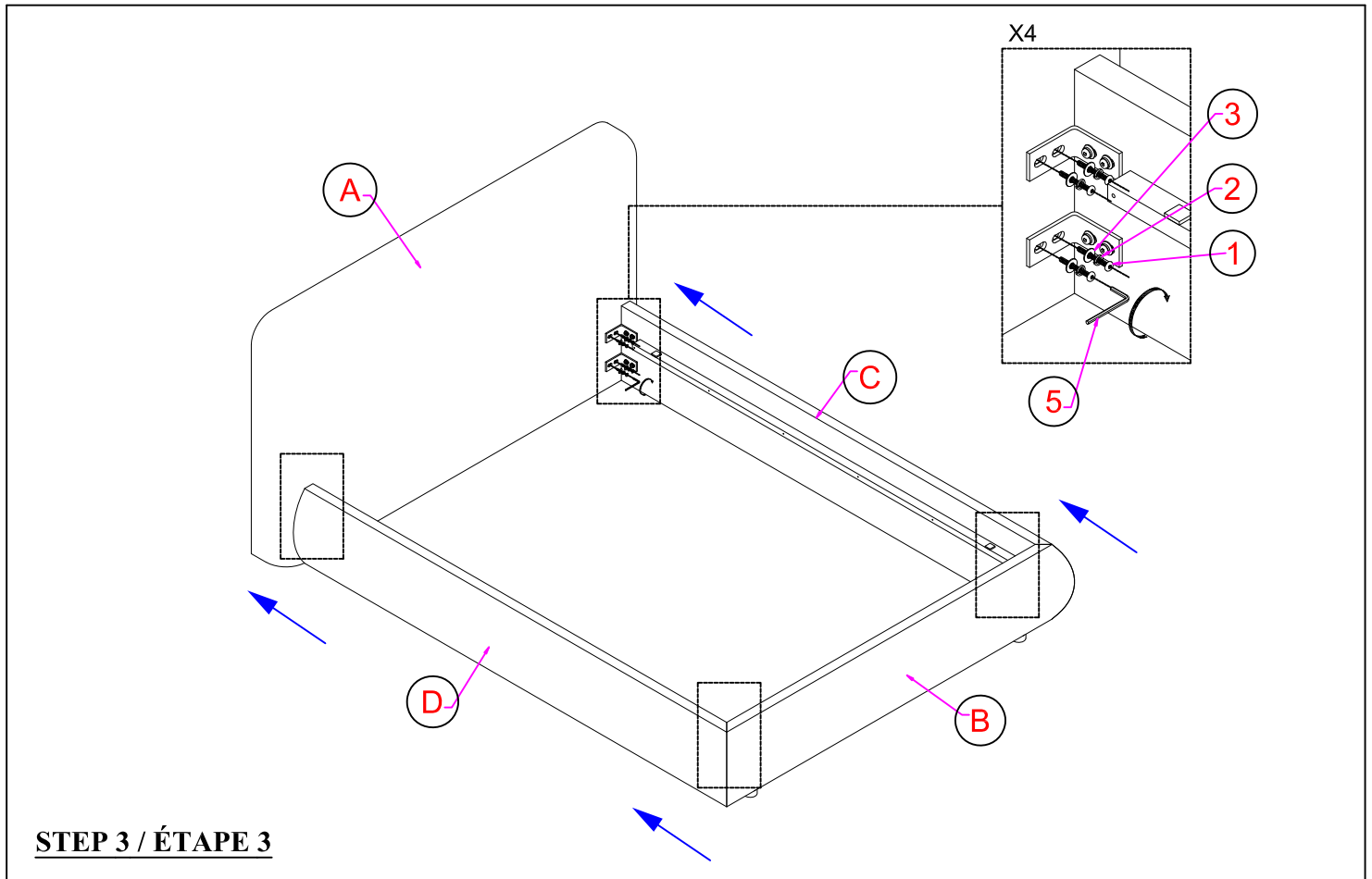

ASSEMBLY INSTRUCTIONS / NOTICE D' ASSEMBLAGE
DESCRIPTION : LUKA FULL BED/ LIT DOUBLE LUKA
ITEM: LUKATFHB/ LUKATFFB/ LUKATFRL
LUKAGFHB/ LUKAGFFB/ LUKAGFRL

COMPLETE

